

Rain Barrel & Universal Diverter Kit Instructions

RAIN BARREL

Installation Tools – Tools required for set up:

Work gloves, hacksaw, level, safety glasses, tape measure, pencil, screwdriver.

Parts List – Rain Barrel, 5 or 6 legs, 1 centre support (smallest of the barrel legs), drain spigot, 2 overflow caps, 20" black connector hose.

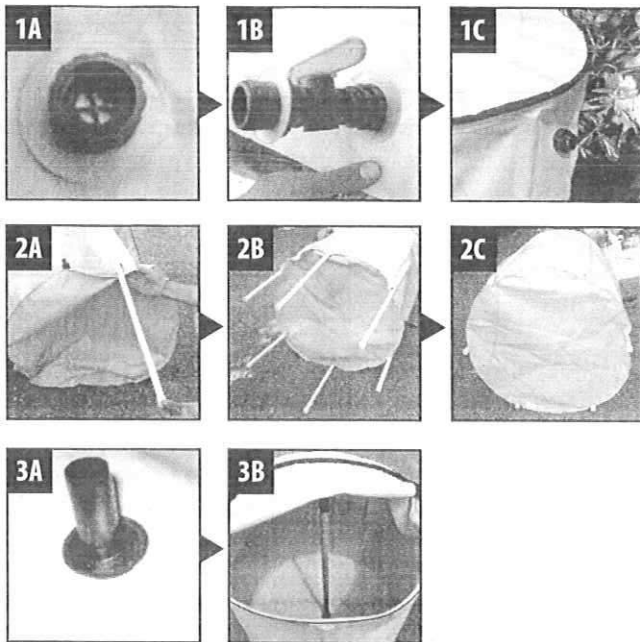
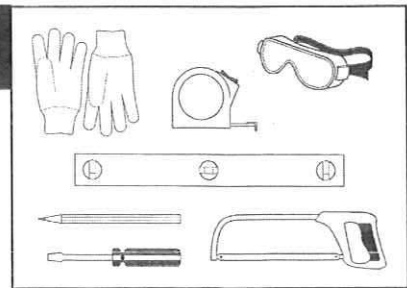

Installation

1. Connect the drain spigot to the fitting at the bottom side of the barrel (see fig 1A and 1B)
Install each overflow fitting on either side of barrel (see Fig 1C) keeping the end with the cap on the inside of the barrel.
2. With rain barrel unfolded and laying on its side install the support legs into the built in sleeves on the sides of the rain barrel making sure the leg caps are positioned at the bottom of the barrel (see Fig 2A, B, C)
3. After the legs are inserted, carefully tilt the rain barrel upright on its legs and install the centre support pole into the bottom plate and also the lid/mesh plate (See Fig 3A and 3B)
4. Zipper lid closed

Rain barrel Location

Choose section of level ground by your selected down spout.
Remove all sharp objects from area.

If not using your included rain diverter, then proceed to step 5

Rain barrels sold with the optional universal diverter kit:

UNIVERSAL DIVERTER KIT INSTALLATION:

This diverter fits both 2"x3" and 3"x4" downspouts.

Equipment Needed: Standard handsaw, measuring tape, screw driver, pencil.

Caution: You are advised before starting any work to wear gloves and use safety glasses when installing the diverter.

Parts List: Diverter body + lid, plug for feeder hose exit, 20" feeder hose.

Options: If you wish to divert rain water to additional areas around the house such as pool or pond, attach a garden hose to the second, top, outlet on the diverter. The factory setting here is covered, this is easily pushed out with a finger or pen.

Marking place on Down Pipe – Level and Stabilize the area

that you place the rain barrel on, it should be near desired downspout. It is recommended that you fill rain barrel with a few inches of water from your hose first to check position and stability.

To install your water diverter at the proper height the diverter should be installed at the same level as relation to the rain barrel hose connector (A+B). Not any higher whereby the rain barrel will overflow or lower whereby the rain water will not get to the barrel.

Once you have decided on the correct place and height mark the point on the down pipe with your pencil.

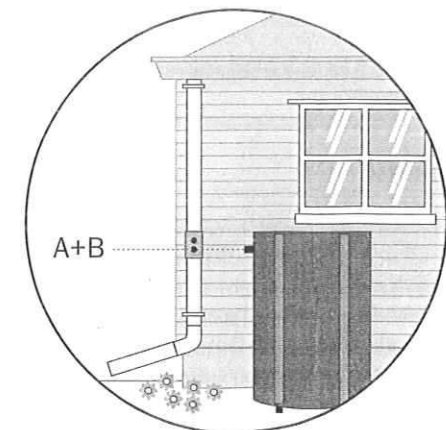
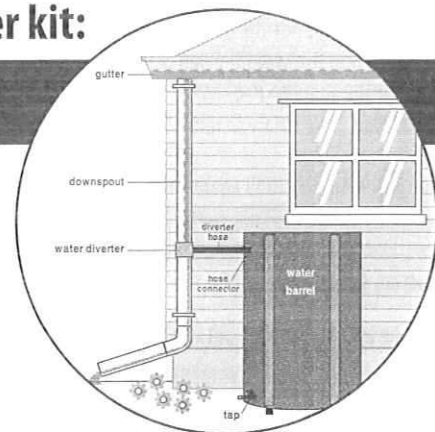

UNIVERSAL DIVERTER KIT INSTALLATION - Continuation

Cutting the Down Pipe:

Mark your downspout for two saw cuts. The first cut should be at the same height as rain barrel hose connector, the second cut should be 1.5" above the first cut of the downspout.

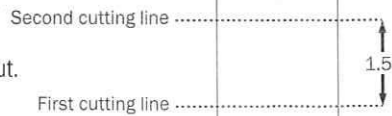

Attach water diverter:

If you have a 3"x4" downspout the 2 size adjusters are not used.

If you have a 2"x3" downspout, use the size adjusters (E) to cover up the extra top area.

With arrow pointing up push diverter onto downspout until it stops (C).

Take lower half of the downspout and push upwards into the bottom of diverter (D).

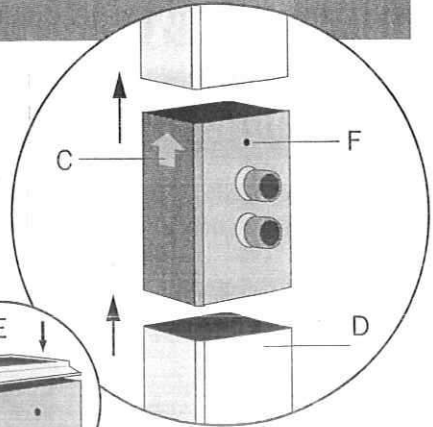
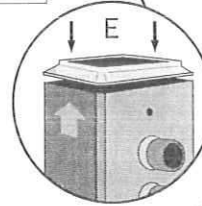

If you loosened the down pipe from the house, you should now reconnect it.

If you find the diverter is loose, you may insert a size 8 screw (F)

Connecting outlets: Your Diverter has 2 water outlets:

Lower Outlet (G) is for the black feeder hose (included) between diverter and your water barrels overflow connection. Remove overflow plug and connect black hose.

Upper Outlet (H) is for a standard garden hose, this may be opened if this extra outlet is desired and easily connected by popping out the plastic cover.

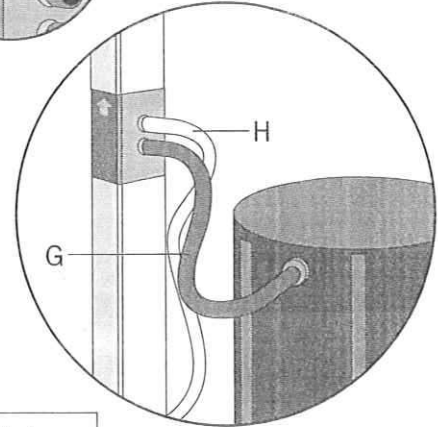

Your product is now ready to use.

! Warning:

Check downspout does not contain heating cables as potential electrocution or fire hazard during Installation.

INSTALLATION WITHOUT UNIVERSAL RAIN DIVERTER KIT:

5. Position the Rain Barrel beside the downspout and mark the downspout

At the mid way point from the top of the rain barrel to the bottom of the rain barrel
Cut of downspout at this mark (see fig 4A)

Note: It may be necessary to remove the downspout from the wall to cut it.

6. Move the rain barrel into position against the wall on a level surface and either place the downspout on the wall above the barrel so rain will fall into the mesh hole or insert it directly into the barrel and zip the lid tightly around the downspout. (See Fig 5A).

Note: The inserted downspout will add stability to the empty barrel until it gets filled with water. However, it is recommended to add a couple of inches of tap water to the barrel for added weight and stability to prevent movement by heavy wind etc.

7. Your rain barrel comes with a 20" black connector pipe and via the additional overflow exits on each barrel you can now connect 2 barrels together and collect even more rain water.

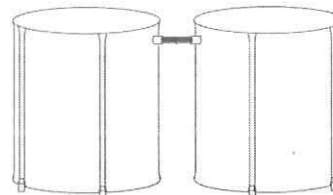
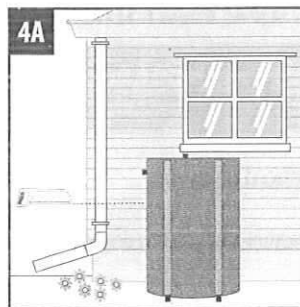

! Warnings:

Never allow children to play in or around rain barrel. Always securely attach lid to avoid child drowning.

The EPA does not recommend this water for human consumption

Always place the barrel on a flat and solid surface. Check the downspout does not contain heating cables before cutting.

When installing use safety glasses and protective gloves.

In areas where freezing may occur, we recommend emptying and storing your rain barrel to prevent damage to the rain barrel.

This is not a toy. Serious injury and/ or death can occur if directions and safety precautions are not followed.

STC is not responsible for damages resulting from improper installation

